



TEL: 800-870-0852
 FAX: 888-707-0679
 E-MAIL: SALES@THERMACTIVE.COM

ThermActive ELECTRONICS

Ø155x95mm BA155-95T Series AC Centrifugal Fan



Specification:

Air Flow	234 ~ 273 CFM
Impeller	Plastic PA (Polyamide Glass-fiber Reinforced)
Motor	Capacitor-Run Induction and External Rotor Motor
Rotor	Black Paint
Bearing	Dual Ball Bearing, Permanently Lubricated
Operating Voltage Range	85VAC to 125VAC for 115V Type 185VAC to 245 VAC for 230V Type
Lead Wire	AWG# 18 UL
Insulation	Class "B" or "F"
Safety	Thermally Protected (Auto Restart)
Operating Temperature	-20°C to +70°C
Weight	1200g



Item Code	Rated Voltage	Frequency (Hz)	Rated Current(A)	Input Power(W)	Speed (RPM)	Air Flow (CFM)	Air Flow (m³/min)	Static Pressure (inch-H ₂ O)	Noise dB(A)	Capacitor (µF)
BA1V155-95T-FPA-B7-2C	115V	50/60	0.34/0.34	34/39	2720/3120	234/270	6.6/7.6	0.95/1.31	62/65	4µF 200VAC
BA2V155-95T-FPA-B7-2C	230V	50/60	0.17/0.18	34/40	2730/3130	238/273	6.7/7.7	0.93/1.22	62/65	1µF 400VAC

Outline Drawing:

Unit:mm(Inch)

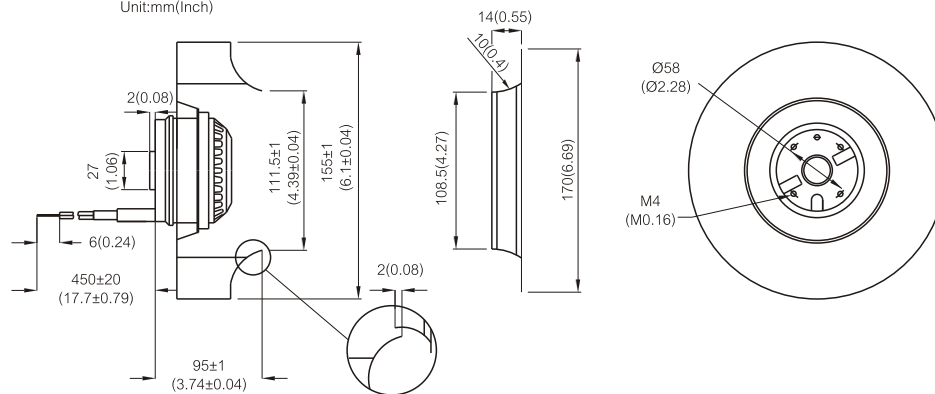

Characteristic Curves:

