



TEL: 800-870-0852
 FAX: 888-707-0679
 E-MAIL: SALES@THERMACTIVE.COM

ThermActive ELECTRONICS

Ø225x69mm BA225-69T Series AC Centrifugal Fan

Specification:



Air Flow	460 ~ 527 CFM
Impeller	Plastic PA (Polyamide Glass-fiber Reinforced)
Motor	Capacitor-Run Induction and External Rotor Motor
Rotor	Black Paint
Bearing	Dual Ball Bearing, Permanently Lubricated
Operating Voltage Range	85VAC to 125VAC for 115V Type 185VAC to 245 VAC for 230V Type
Lead Wire	AWG# 18 UL
Insulation	Class "B" or "F"
Safety	Thermally Protected (Auto Restart)
Operating Temperature	-20°C to +60°C
Weight	1420g



Item Code	Rated Voltage	Frequency (Hz)	Rated Current(A)	Input Power(W)	Speed (RPM)	Air Flow (CFM)	Air Flow (m³/min)	Static Pressure (inch-H ₂ O)	Noise dB(A)	Capacitor (µF)
BA1V225-69T-FPA-B7-2C	115V	50/60	0.92/0.99	94/113	2600/3000	460/526	13.0/14.9	1.96/2.67	68/71	12µF 200VAC
BA2V225-69T-FPA-B7-2C	230V	50/60	0.47/0.53	98/121	2600/3000	461/527	13.1/14.9	1.96/2.67	68/71	3µF 400VAC

Outline Drawing:

Unit:mm(Inch)

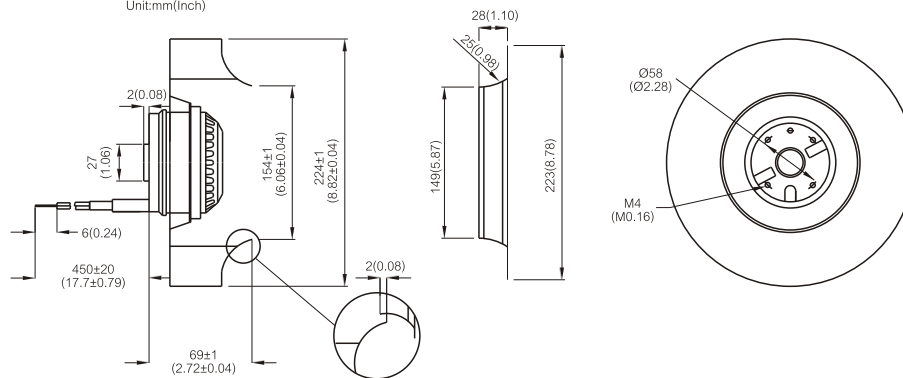

Characteristic Curves:

