



TEL: 800-870-0852
 FAX: 888-707-0679
 E-MAIL: SALES@THERMACTIVE.COM

ThermActive ELECTRONICS

Ø190x69mm BA190-69T Series AC Centrifugal Fan



Specification:

Air Flow	339 ~ 378 CFM
Impeller	Plastic PA (Polyamide Glass-fiber Reinforced)
Motor	Capacitor-Run Induction and External Rotor Motor
Rotor	Black Paint
Bearing	Dual Ball Bearing, Permanently Lubricated
Operating Voltage Range	85VAC to 125VAC for 115V Type 185VAC to 245 VAC for 230V Type
Lead Wire	AWG# 18 UL
Insulation	Class "B" or "F"
Safety	Thermally Protected (Auto Restart)
Operating Temperature	-20°C to +70°C
Weight	1360g



Item Code	Rated Voltage	Frequency (Hz)	Rated Current(A)	Input Power(W)	Speed (RPM)	Air Flow (CFM)	Air Flow (m³/min)	Static Pressure (inch-H ₂ O)	Noise dB(A)	Capacitor (µF)
BA1V190-69T-FPA-B7-2C	115V	50/60	0.54/0.64	60/73	2480/2750	339/376	9.6/10.6	1.34/1.81	63/66	8µF 200VAC
BA2V190-69T-FPA-B7-2C	230V	50/60	0.27/0.33	60/73	2490/2760	341/378	9.7/10.7	1.34/1.81	63/66	2µF 400VAC

Outline Drawing:

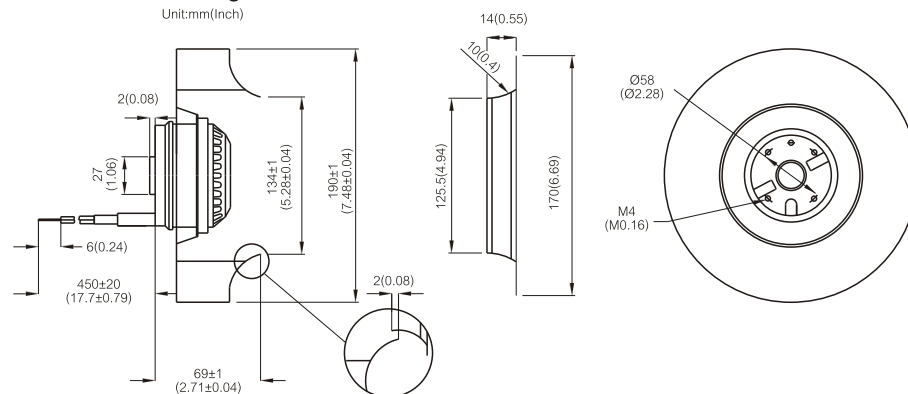

Characteristic Curves:

